

Inkl. Randblende

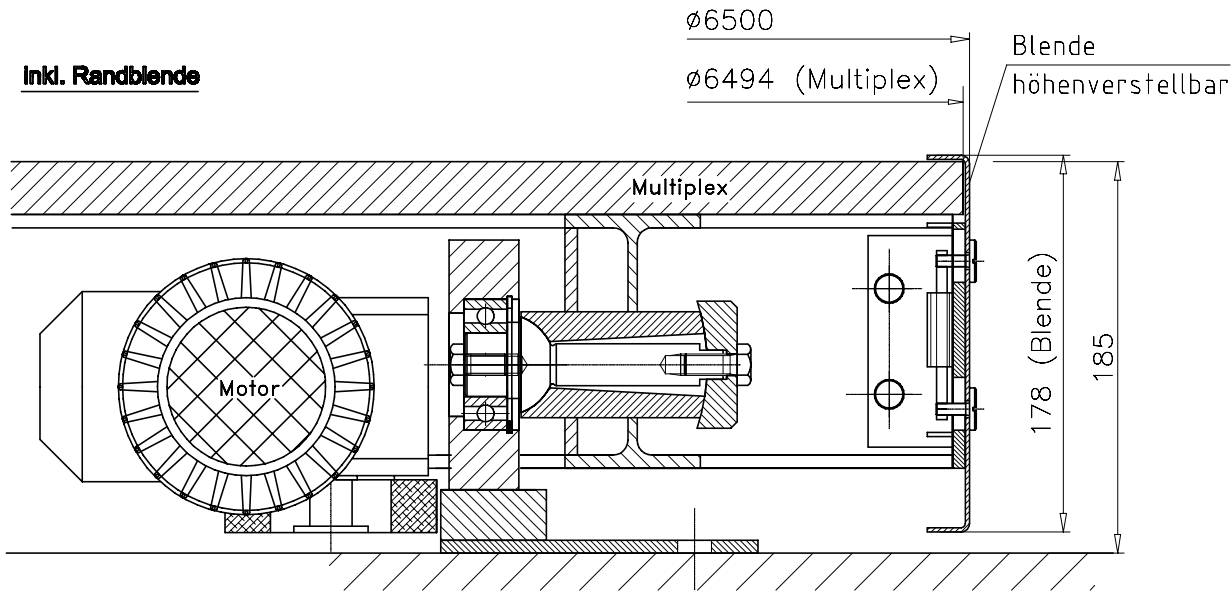

ohne Randblende

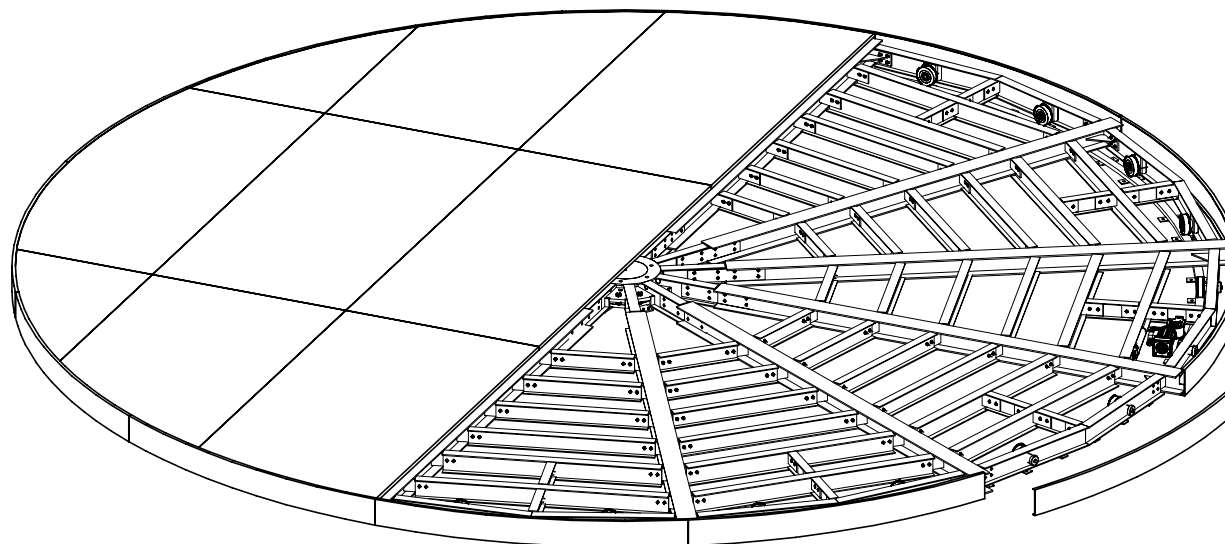
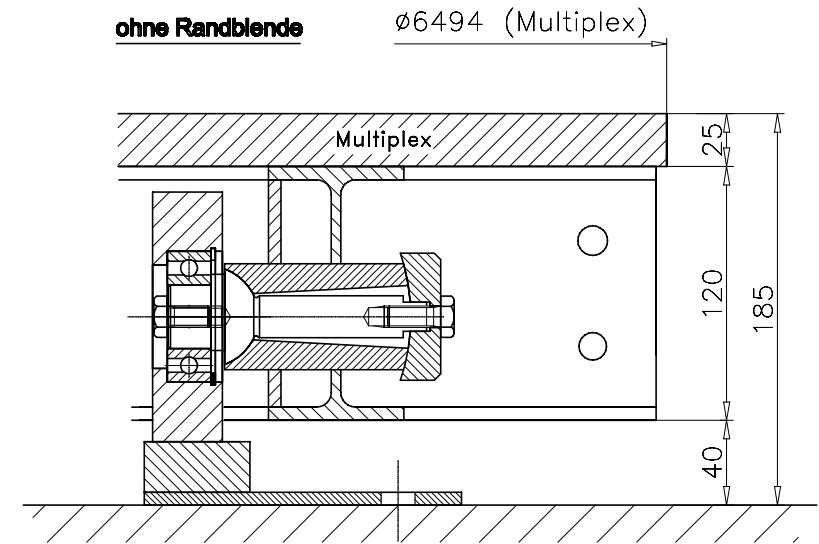

Drehscheibe Typ DSMA 65/60-12 NL

Bumat Bewegungssysteme GmbH
Pfälzer Ring 30
D-68766 Hockenheim

Tel.: +49 (0) 6205.9413-30
Fax: +49 (0) 6205.9413-55
info@bumat.com
www.bumat.com

